

# INDICATORS NEF22T

## DATA SHEET

no: KK- W\_NEF22T



Signal indicators constitute a special type of signal lamps. Luminous elements are based on LEDs, which feature high durability and low energy consumption. In comparison to basic lamps, indicators differ by using several LEDs that are illuminated in groups and produce certain signs, as adopted in electrical engineering and automatics. In addition, the use of an all-purpose current stabilization module for LEDs makes it possible for indicators to work under any voltage within the 24-230V AC/DC range (the only exception being the phase presence indicator that requires 230V AC/DC voltage).

All signal indicators can be applied in difficult industrial conditions. Bodies of the NEF22T indicators are made of plastic. The glass cover is made of transparent polycarbonate, which is a material resistant to mechanical impacts and flame retardant.

The NEF22T indicators are intended for building in standardized  $\varnothing 22.5$ mm holes – drilled in various types of control and signal equipment, or directly into bodies of machines and equipment.

## TECHNICAL DATA:

Parameter	Value
Insulation rated voltage $U_i$	250V 500V for NEF22TWF
Rated voltage $U_e$	24-230V AC/DC 230V AC for NEF22TWF
Type of luminous element	LED
IP for over-desk part IP for under-desk part	IP 66/67 IP 20
Cross-sections of terminals	1x or 2x LY 0,75-1,5mm <sup>2</sup> 1x or 2x DY 1-1,5 mm <sup>2</sup>
Maximum thickness of desk	6mm
Working temperature	<b>N/2</b> -15...+30°C <b>W/3</b> -30...+50°C

The product conforms to the following standard PN-EN 60947-5-1.

## POSITION INDICATORS

They are used in automatic systems and power engineering systems for commercial applications, and particularly for signaling positions of contacts in switches, disconnecting switches, etc., in synoptic boards of hydraulic and pneumatic systems, and of steam networks, to signal positions of valves or bolts. The luminous element in a position indicator is comprised of 10 LEDs, arranged in the shape of two perpendicular beams. Depending on the colour of LEDs, the indicators are produced in a number of versions.

	Designation	Colour	Weight [g]
	NEF22TWP cz NEF22TWP gz NEF22TWP cg NEF22TWP g NEF22TWP z NEF22TWP c	red-green yellow-green red-yellow yellow green red	39

## PHASE PRESENCE INDICATORS

They are used in three-phase current circuits. They indicate the presence of voltage in each of the three phases. Signal elements are comprised of three LEDs that signal the correctness of operation for each of the three phases: yellow (L1) – phase 1; green (L2) – phase 2; and red (L3) – phase 3.

	Designation	Colour	Weight [g]
	NEF22TWF	yellow-green-red	40

## EARTHING INDICATORS

They can be used to signal the status of an earthing switch and to indicate, whether a particular electric circuit is earthed. Yellow LEDs are arranged in such way that they make the symbol of earthing.

	Designation	Colour	Weight [g]
	NEF22TWU g NEF22TWU z NEF22TWU c	yellow green red	37

## SWITCH POSITION INDICATORS

They are used to signal the status of position for switches, cut off switches, disconnecting switches, etc. The indicator has a masking plate under the transparent glass cover. The plate contains a conventional symbol of the indicator's contact and three LEDs, each in different colour.

	Designation	Colour	Weight [g]
	NEF22TWPW	yellow-green-red	40

**DIMENSIONS**

**NEF22TWU**



**NEF22TWP**



**NEF22TWF**

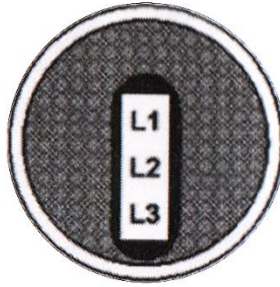

**NEF22TWPW**

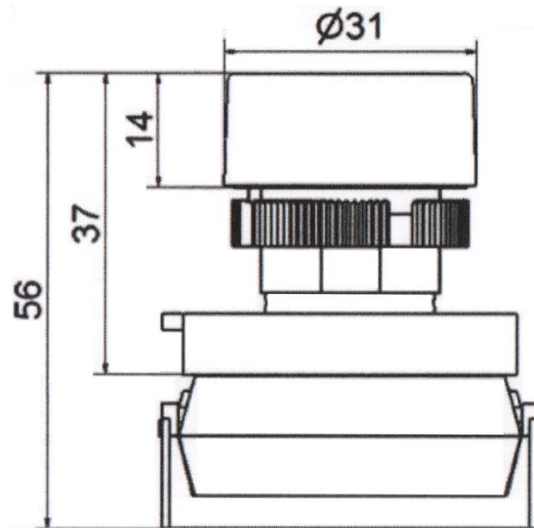

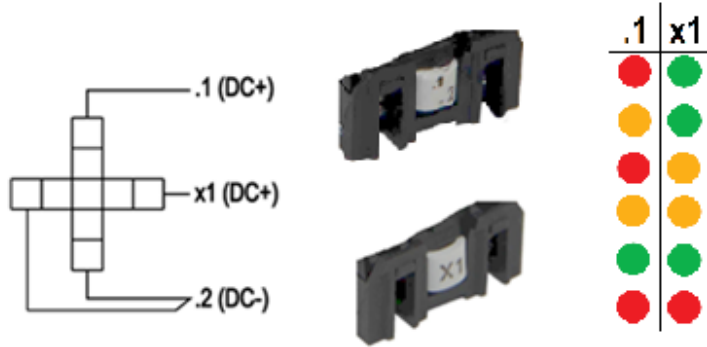
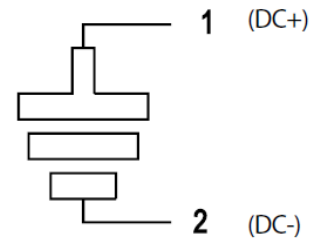
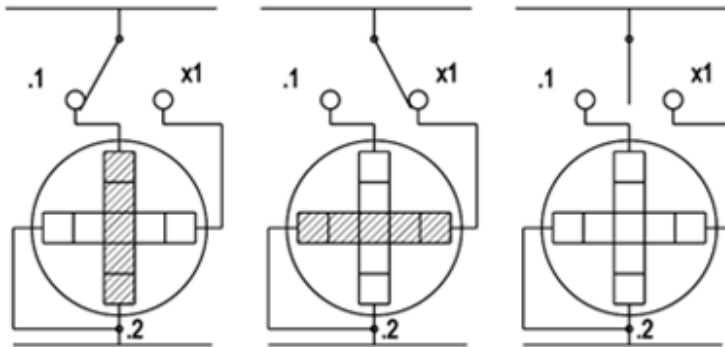
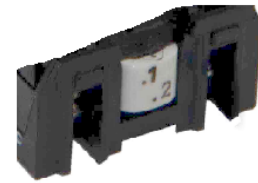
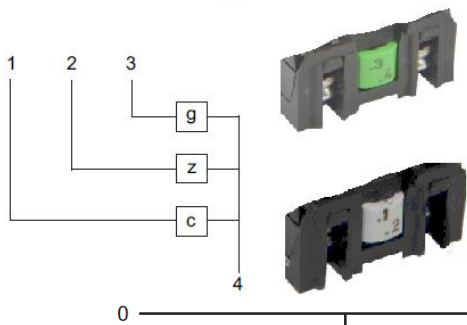
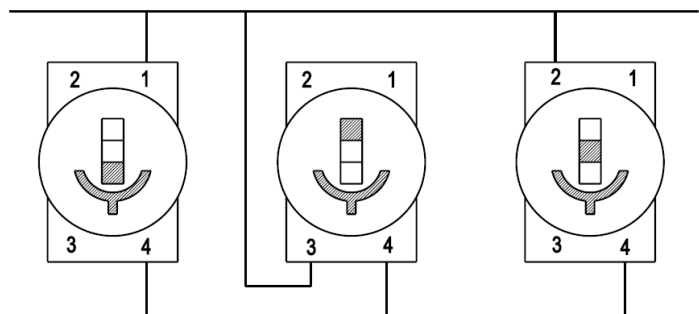
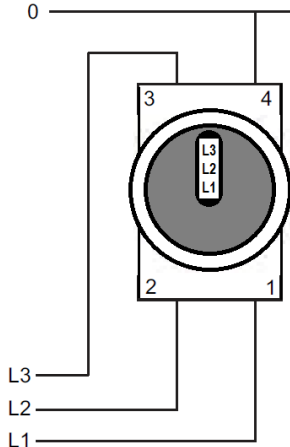
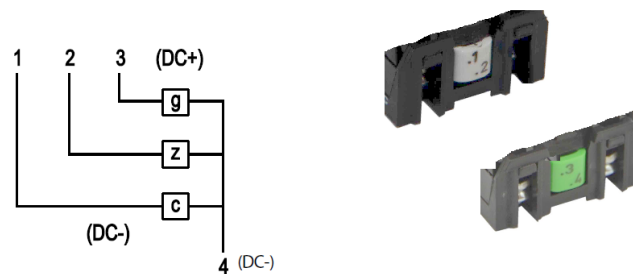
**CIRCUIT DIAGRAMS**
**WP**

**WU**

**WF**

**WPW**

**OPERATION**

red LED

**TRIAL**

yellow LED

**SHUTDOWN**

green LED